

dji OSMO MOBILE 7

Quick Start Guide 快速入门指南

v1.0

Instrukcja obsługi

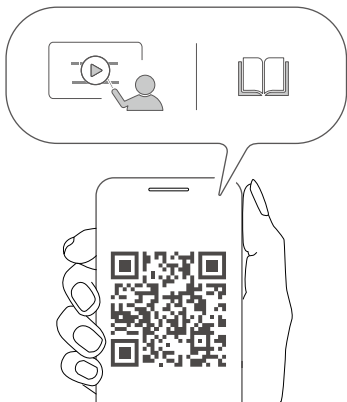
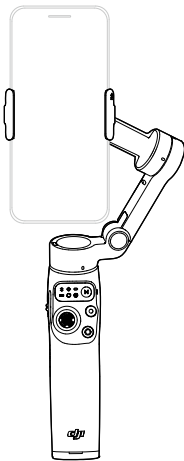

<https://s.dji.com/guide97>



Contact
DJI SUPPORT



微信扫一扫
获取技术支持

DJI is a trademark of DJI.
OSMO is a trademark of DJI OSMO.
Copyright © 2025 DJI All Rights Reserved.



YCBZ5500304903

1

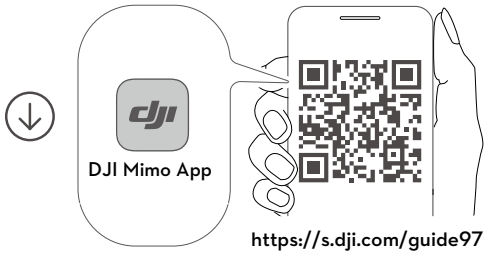

2

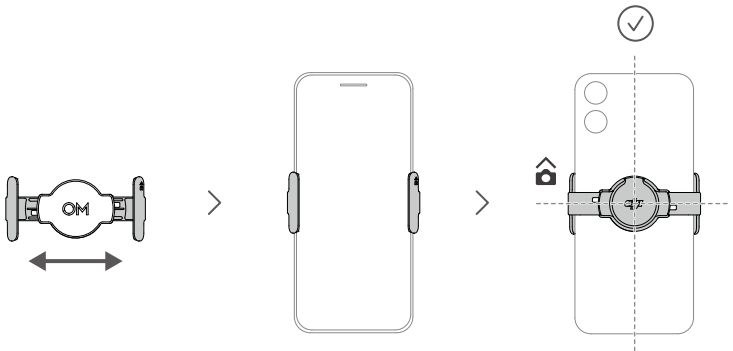

3

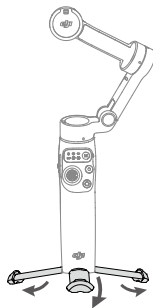
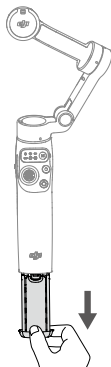
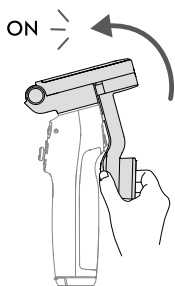

4

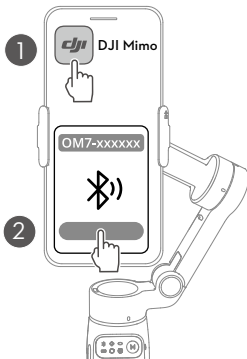
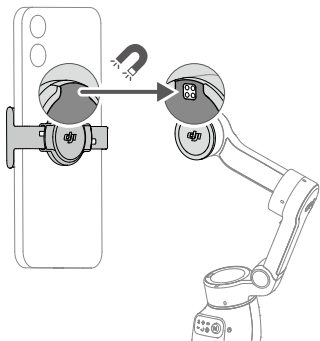

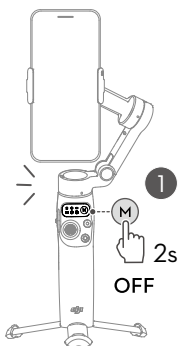

>

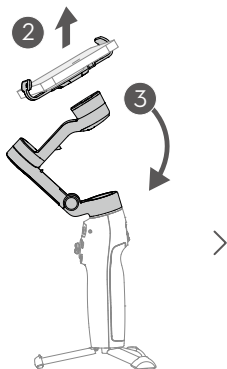

>

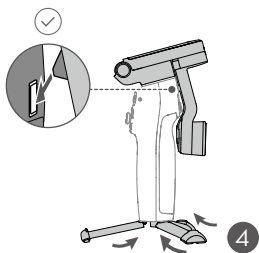

>

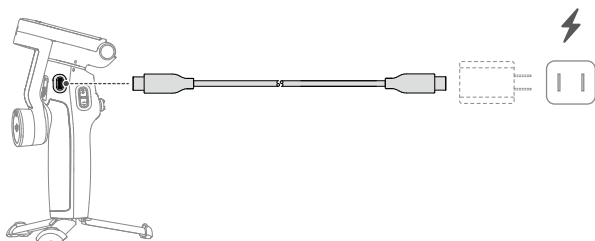
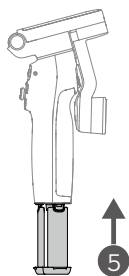

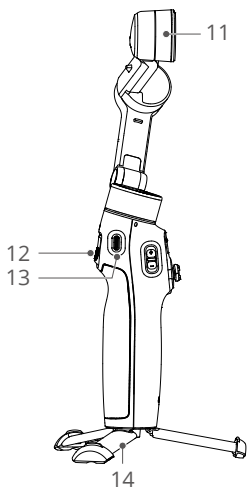
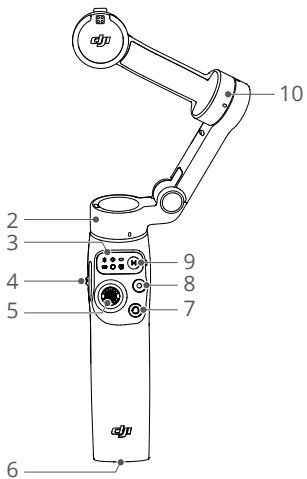

EN

1. DJI OM Magnetic Phone Clamp 4
2. Pan Motor
3. Status Panel
4. Zoom Slider
5. Joystick
6. 1/4"-20 UNC Port
7. Switch Button
8. Shutter/Record Button
9. Power/M Button
10. Tilt Motor
11. Roll Motor
12. Trigger
13. Charging Port (USB-C)
14. Built-in Tripod

CHS

1. DJI OM 磁吸手机夹 4
2. 平移轴电机
3. 状态显示面板
4. 变焦滑杆
5. 摇杆
6. 1/4" -20 UNC 螺纹孔
7. 切换按键
8. 拍摄按键
9. 电源 / M 按键
10. 俯仰轴电机
11. 横滚轴电机
12. 扳机按键
13. 充电接口 (USB-C)
14. 内置三脚架

PL

1. Magnetyczny zacisk telefonu 4 do DJI OM
2. Silnik panoramowania
3. Panel stanu
4. Suwak zoomu
5. Manipulator
6. Port 1/4"-20 UNC
7. Przycisk przełączający
8. Przycisk Migawka/Nagrywanie
9. Przycisk zasilania/M
10. Silnik pochylecia
11. Silnik przechylecia
12. Spust
13. Port ładowania (USB-C)
14. Wbudowany statyw